

Escalator Components

扶梯部件

塞维拉扶梯部件制造中心始建于2006年，目前已具有成熟的冷弯轧制、冲压、金属切削等生产技术，专业生产各类规格的自动扶梯用冷弯型材及配件。公司拥有德国数控滚压成型机、台湾滚压成型机、英国数控螺柱焊机、光纤切割机、数控剪板机、数控折弯机、数控冲床、高速冲床及配套的六连线机械手设备、日本拉弯机等先进设备。目前扶梯部件制造中心员工270余人、专业技术人员20余人。通过十几年的努力，公司已经成为中国自动扶梯行业中规格品种最全的生产制造企业之一。

Savera Sanyong, the escalator components manufacturing center of Savera Group, was established in 2006. The main products include escalator driving guide rail system, balustrade guide rail and panel system, skirting system, and related accessories. The company is well equipped with CNC machineries of international brands and has more than 280 personnel, 20 of which are engineers. After more than 10 years' effort, the company has developed the know-how of cold-bending, roller pressing, punching technology, and has possessed one of the most complete product portfolio of escalator mechanical components in the industry.



Driving guide rails 驱动导轨

去路驱动导轨 Driving guide rail

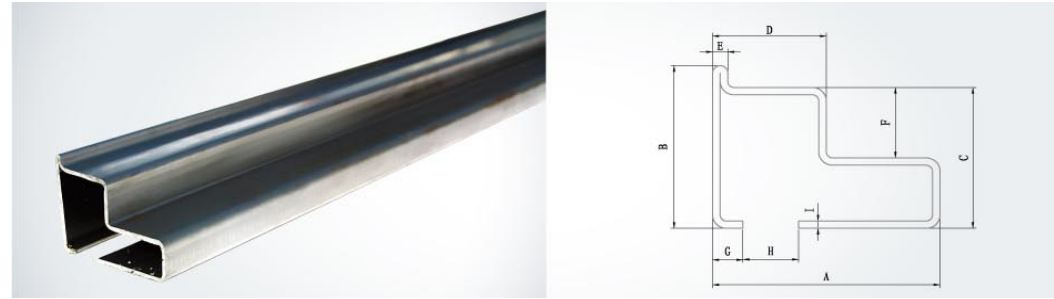

回路随动导轨 Secondary counter rail

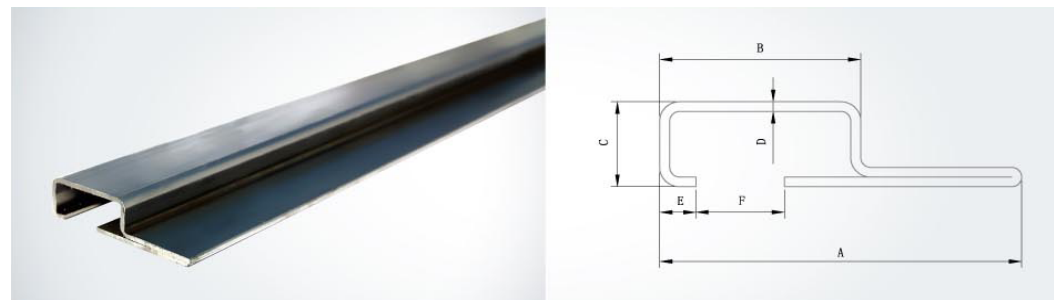

回路驱动导轨 Driving counter rail

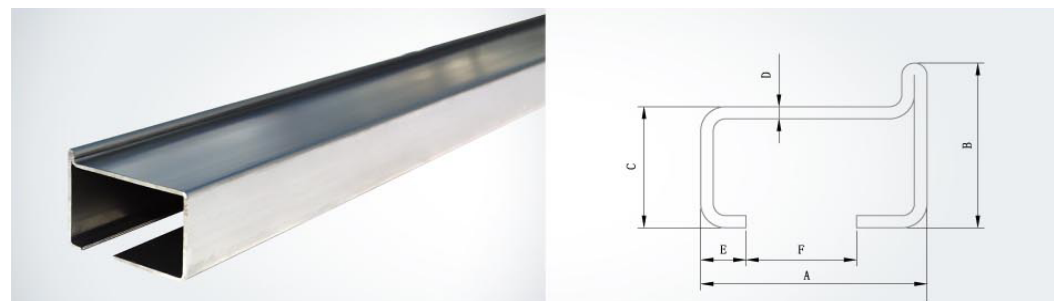

Balustrade guide rails system

扶手导轨组件

扶手转角栏杆 Balustrade header

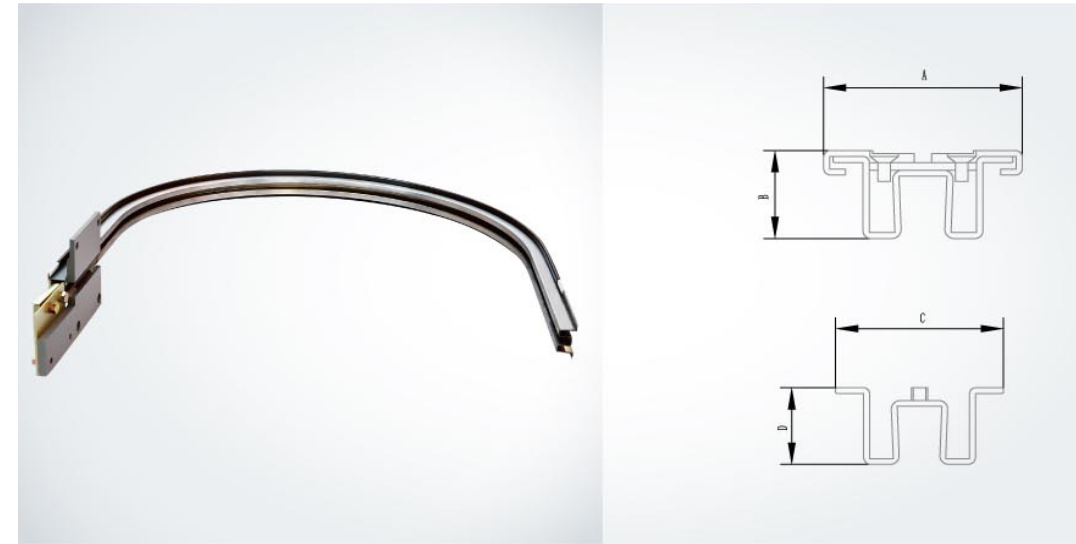

上下弯曲扶手导轨 Curving balustrade



扶手转角栏杆 Balustrade header



扶手导轨组件 Balustrade guide rail set

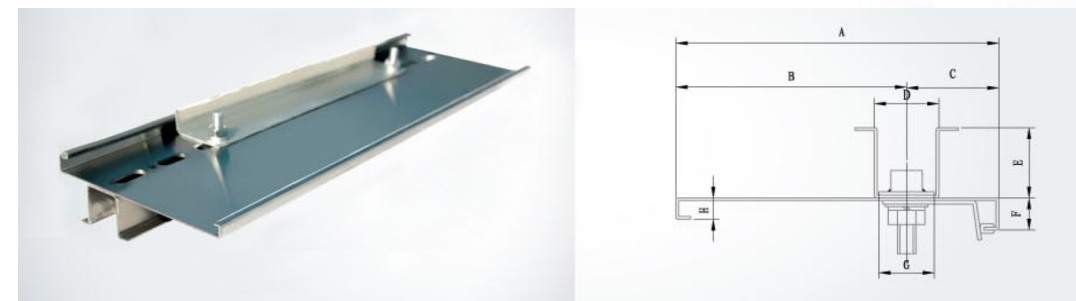

Escalator balustrade panel, skirting panel

扶梯装饰部件： 盖板、裙板、支架

内盖板 Interior panel

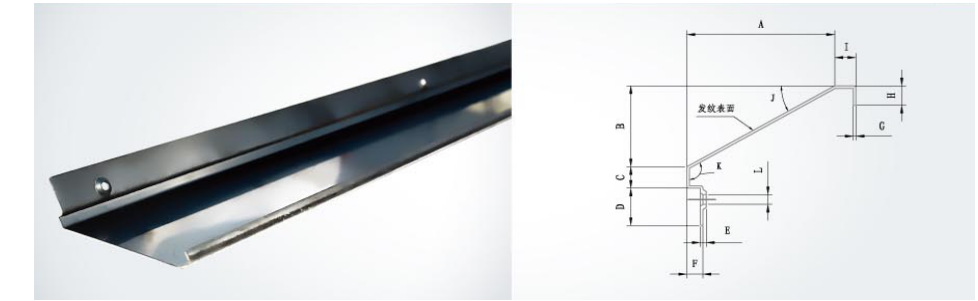

梳齿围裙板 Comb skirting plate



外盖板 Exterior panel

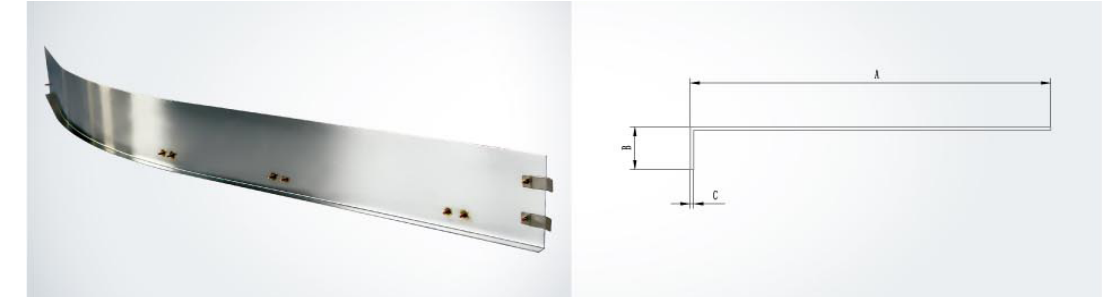

弯曲围裙板 Curving skirting plate

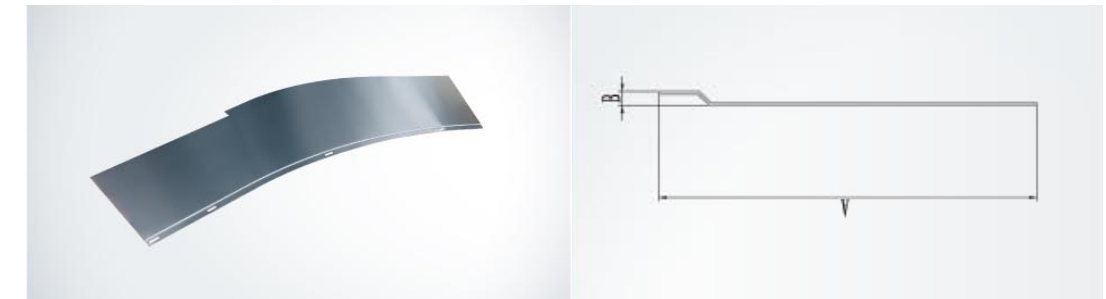

内盖板 Curving interior panel

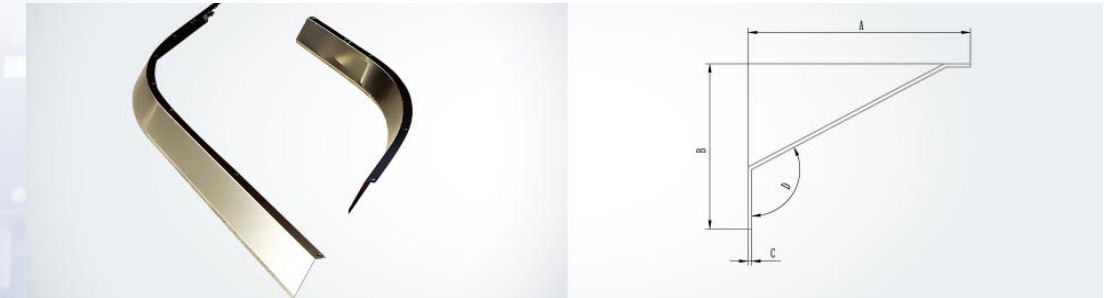

Glass Holding System 玻璃保持组件

玻璃保持器 Glass bracket



玻璃夹具 Glass holder



压条 Glass clipper

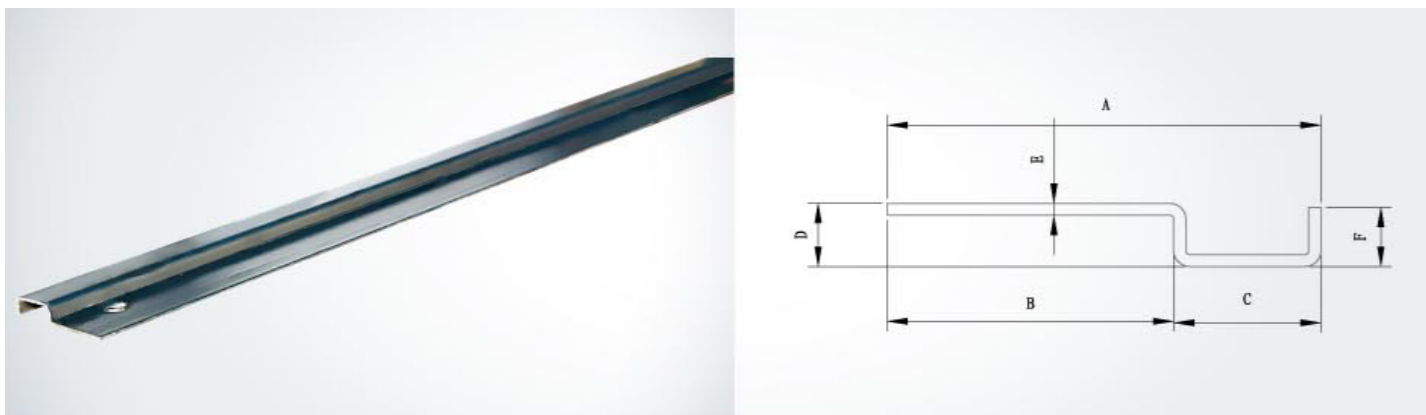

Mechanical Components 机械部件

塞维拉三永机械有限公司
Savera Sanyong Machinery Co., Ltd.
Tel: +86 573 87972128
Email: sales@sanyongjx.com
浙江省海宁市长安镇(高新区)春潮路7号
No.7 Chunchao Rd., Haining, Zhejiang Province, P.R. China
Postcode 邮编: 314408

苏州塞维拉上吴电梯轨道系统有限公司
Suzhou Savera Shangwu Elevator Riding System Co., Ltd.
Tel: +86 512 63244618
E-mail: shangwu_sales@saveragroup.js.cn
中国苏州吴江北库镇开发区内
West Beishe, Wujiang, Jiangsu, P.R. China
Postcode 邮编: 215214

广州塞维拉电梯轨道系统有限公司
Guangzhou Savera Elevator Riding System Co., Ltd.
Tel: +86 20 39965678
E-mail: guangzhou_sales@saveragroup.gd.cn
中国广州市番禺区石楼镇国贸大道南636号之二
No.2 South Guomao Avenue 636, Shilou Town, Panyu District,
Guangzhou, P.R. China
Postcode 邮编: 511447

西班牙EMESA电梯部件有限公司
Estampaciones Metálicas Épila, S.A.
Tel: +34 976 819 191 Fax: +34 976 603 998
Email: Emesa@saveragroup.com
西班牙萨拉戈萨艾比拉市
Camino del Sabinar s/n, Pol. Industrial Valdemuel, Épila(Zaragoza -
Spain)
Postcode 邮编: 50290

天津塞维拉电梯轨道系统有限公司
Tianjin Savera Elevator Riding System Co., Ltd.
Tel: +86 22 86858002 Fax: +86 22 86990080
E-mail: sales.dept@saveragroup.tj.cn
天津市北辰区高端装备园永乐道30号
No.30 Yongle Road, Beichen economic and technological
development zone, Tianjin, P. R. China.
Postcode 邮编: 300400

铜陵旋力塞维拉精密制造有限公司
Tongling Savera Xuanli Precision Manufacturing Co., Ltd
Tel: +86 2152278882
E-mail: services@saveragroup.com.cn
铜陵市义安区东联镇杭州路
Yongtai Road, Yi'an District, Tongling, Anhui, China
邮编: 244100



Elevator System Solutions

Escalator Components 扶梯部件



Mechanical Components 机械部件



Elevator System Solutions